



Timer/Counter/Analyzer
CNT-90, CNT-91, CNT-90/AN

Frequency Calibrator/Analyzer
CNT-91R

Microwave Counter/Analyzer
CNT-90XL

**GETTING STARTED
MANUAL**



Part No.: 4031-600-90401
Revision: 1
Date: 6 March, 2020

Table of Contents

Introduction

Introduction	1-2
About this Manual	1-2
Warranty.....	1-2
Declaration of Conformity.....	1-2
Safety Precautions.....	1-3
Caution and Warning Statements	1-3
Symbols.....	1-3
If in Doubt about Safety.....	1-4

Preparation for Use

Unpacking	2-2
Check List.....	2-2
Identification.....	2-2
Reading the Electronic Manuals	2-2
Installation.....	2-2
Supply Voltage	2-2
Setting	2-2
Fuse	2-2
Grounding.....	2-3
Rear Panel.....	2-3
Line Power Inlet	2-3
Reference Output.....	2-3
External Reference Input	2-3
External Arming Input.....	2-3
GPIB/IEEE-488 Connector.....	2-3
USB Connector	2-4
Optional Main Input Connectors	2-4
Fan.....	2-4
Type Plate	2-4
Orientation and Cooling.....	2-4
Fold-Down Support	2-4
Rackmount Adapter	2-4

Operating the Counter

Introduction	3-2
User Interface	3-2
Getting Familiar with the Counter.....	3-2
Description of Keys.....	3-3
Power	3-3
Select Function	3-3
Autoset/Presets	3-3
Move Cursor.....	3-3
Enter.....	3-3
Exit/OK.....	3-3
Cancel	3-3

Presentation Modes	3-4
VALUE.....	3-4
STAT/PLOT.....	3-4
Remote	3-5
Hard Menu Keys.....	3-5
Input A	3-5
Input B	3-5
Settings.....	3-6
Math/Limit.....	3-7
User Options	3-8
Hold/Run.....	3-9
Restart	3-9
Entering Numeric Values.....	3-9

Exercises

Preparation.....	4-2
Basic Startup.....	4-2
High-Resolution Frequency Measurement	4-2
Built-In Math Processing.....	4-2
High-Speed Measurements.....	4-3
Under the INPUT Menus:.....	4-3
Under the SETTINGS Menu:.....	4-3
Time Measurements.....	4-4
Jitter Measurements (Statistics).....	4-4
Other Single-Channel Measurements.....	4-4
Duty Cycle.....	4-4
Rise Time.....	4-5
Fall Time.....	4-5
Remarks.....	4-5
Volt Max/Min Measurements.....	4-5
Channel Swapping.....	4-5
Two-Channel Measurements.....	4-6
Time Interval.....	4-6
Phase.....	4-6
Using Auto to set fixed trigger levels (Auto Once)	4-6
Procedure.....	4-6
Memory Settings.....	4-6
Auxiliary Functions.....	4-7
Time-Out.....	4-7
Summary.....	4-7
Sales & Service Offices.....	V

Introduction

Introduction

Congratulations on your choice of instrument. It will serve you well for many years to come.

Even though we know that you are eager to get going, we urge you to take a few minutes to read through the sections on safety in the first two chapters carefully before plugging the line connector into the wall outlet.

It is essential for your own safety to know the restrictions that are applicable to all equipment that can be connected to line power.

Therefore, read about Safety Precautions on page 1-3 and Installation on page 2-2.

That chapter is also the key to the comprehensive information that can be found on the included CD, if you need closer information on a subject.

About this Manual

This manual contains directions for use that are common to all Timer/Counter/Analyzers in the CNT-9X series.

In order to simplify the references, the CNT-9X is further referred to throughout this manual as the '9X'.

Warranty

The Warranty Statement is part of the folder Important Information that is included with the shipment.

Declaration of Conformity

The complete text with formal statements concerning product identification, manufacturer and standards used for type testing is available on request.

Safety Precautions

This instrument has been designed and tested for Measurement Category I, Pollution Degree 2, in accordance with EN/IEC 61010-1:2001 and CAN/CSA-C22.2 No. 61010-1-04 (including approval). It has been supplied in a safe condition. The user must have acquired adequate knowledge of it by thoroughly studying this manual.

To ensure the correct and safe operation of the instrument, it is essential that you follow generally accepted safety procedures in addition to the safety precautions specified in this manual.

The instrument is designed to be used by trained personnel only. Removing the cover for repair, maintenance, and adjustment of the instrument must be done by qualified personnel who are aware of the hazards involved.

The warranty commitments are rendered void if unauthorized access to the interior of the instrument has taken place during the given warranty period.

Caution and Warning Statements

CAUTION: Shows where incorrect procedures can cause damage to, or destruction of equipment or other property.

WARNING: Shows a potential danger that requires correct procedures or practices to prevent personal injury.



Do not overlook the safety instructions!

Symbols



Shows where the protective ground terminal is connected inside the instrument. Never remove or loosen this screw.



This symbol is used for identifying the functional ground of an I/O signal. It is always connected to the instrument chassis.



Tells the operator to consult the manual.

Example:

One such symbol is printed on the instrument below the A and B inputs. It indicates that the damage level for the input voltage decreases from 350 Vp to 12 VRMS when you switch the input impedance from 1 M Ω to 50 Ω . of the instrument has taken place during the given warranty period.

If in Doubt about Safety

Whenever you suspect that it is unsafe to use the instrument, you must make it inoperative by doing the following:

- Disconnect the line cord.
- Clearly mark the instrument to prevent its further operation.
- Inform your Pendulum representative.

For example, the instrument is likely to be unsafe if it is visibly damaged.

Preparation for Use

Unpacking

Check that the shipment is complete and that no damage has occurred during transportation. If the contents are incomplete or damaged, file a claim with the carrier immediately. Also notify your local Pendulum sales or service organization in case repair or replacement may be required.

Check List

The shipment should contain the following:

- The counter, Model CNT-9X.
- Line cord.
- N-to-BNC Adapter (only for CNT-90/91 (R) Option 10 build in).
- Built-in options as ordered should be installed. See Identification below.
- Folder with Important Information.
- Certificate of Calibration.
- A CD-ROM including the following documentation in PDF:
 - Getting Started Manual,
 - User's Manual,
 - Programmer's Handbook.

Identification

The type plate on the rear panel shows the type number and the serial number. See illustration on page 2-4. Installed options are listed under the menu User Options - About, where you can also find information on firmware version and calibration date. See page 3-8.

Installed options can also be identified by checking the full type number on the type plate.

Reading the Electronic Manuals

You need the Adobe® Reader® software to be able to read the manuals on the CD. It is included on the CD or can be downloaded free of charge from www.adobe.com.

Insert the CD into the CD-ROM unit of your PC or Mac and select the file you are looking for from the index.

Installation

Supply Voltage

Setting

The Counter can be connected to any AC supply with a voltage rating of 90 to 265 VRMS , 45 to 440 Hz. The counter automatically adjusts itself to the available line voltage.

Fuse

The secondary supply voltages are electronically protected against overload or short circuit. The primary line voltage side is protected by a fuse located in the power supply unit.

The fuse rating covers the full voltage range. Consequently there is no need for the user to replace the fuse under any operating conditions, nor is it accessible from the outside.

CAUTION: If this fuse is blown, it is likely that the power supply is badly damaged. Do not replace the fuse. Send the counter to the local Service Center.

Removing the cover for repair, maintenance and adjustment must be done by qualified and trained personnel only, who are fully aware of the hazards involved.

The warranty commitments are rendered void if unauthorized access to the interior of the instrument has taken place during the given warranty period.

Grounding

Grounding faults in the line voltage supply will make all instruments connected to it potentially dangerous. Before connecting any unit to the power line, you must make sure that the protective ground functions correctly. Only then can a unit be connected to the power line and only by using a three-wire line cord. No other method of grounding is permitted. Extension cords must always have a protective ground conductor.

CAUTION: If a unit is moved from a cold to a warm environment, condensation may cause a shock hazard. Ensure, therefore, that the grounding requirements are strictly met. Allow enough time for the instrument to adapt to new ambient conditions before connecting it to line power.

WARNING: Never interrupt the grounding cord. Any interruption of the protective ground connection inside or outside the instrument or disconnection of the protective ground terminal is likely to make the instrument dangerous.

Rear Panel

See the figure overleaf for the location of the connectors. The labels refer to the headings below, where the characteristics are summarized. See the User's Manual for technical specifications.

Line Power Inlet

AC 90-265 VRMS, 45-440 Hz, no rangeswitching needed.

Reference Output

10 MHz derived from the internal or the external reference, depending on which of them is the active Measurement Reference. The choice is made from the Settings Menu.

External Reference Input

If the Measurement Reference is set to Auto in the Settings Menu, this input will be automatically selected, provided a valid signal is present.

External Arming Input

Supports external arming (synchronization) of measurements. The main inputs A & B can also be selected for measurement arming via the Settings Menu.

GPIO/IEEE-488 Connector

The address is set from the User Options Menu.

USB Connector

A serial interface according to USB 2.0. 12 Mb/s provides a fast communication link to your PC.

Optional Main Input Connectors

This factory-installed option replaces the ordinary front panel main input connectors.

Fan

Forced cooling is provided by means of a speed-controlled fan. The CNT-90 rear panel layout.

Type Plate

Here you can find the type number and the serial number as well as information on rated line voltage and power.

Orientation and Cooling

The counter can be operated in any position desired. Make sure the air flow through the ventilation slots at the side panels is not obstructed. Leave 5 centimeters (2 inches) of space around the counter.

Fold-Down Support

For bench top use, a fold-down support is available for use underneath the counter. This support can also be used as a handle to carry the instrument.

Rackmount Adapter

An optional rackmount kit is available. See the User's Manual for installation details.

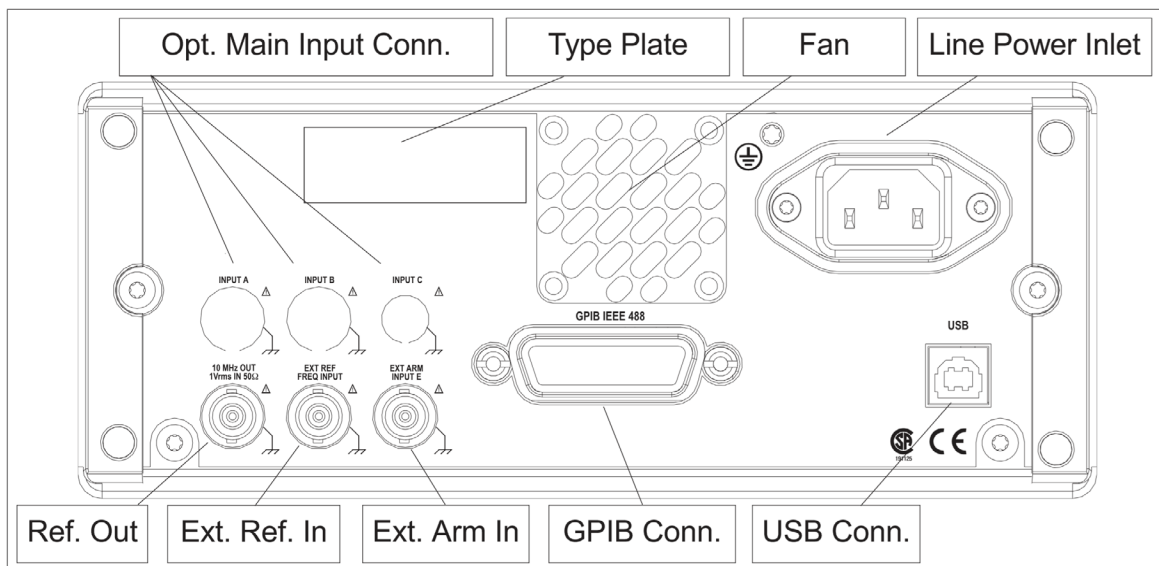

The CNT-90 rear panel layout.

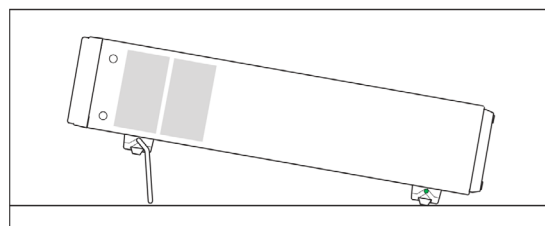

Fold-down support for comfortable bench-top use.

Operating the Counter

Introduction

While this counter has a vast array of features and operating modes, the majority of the most useful functions can be learned in just a few minutes. The following descriptions and exercises will help you grasp the basics of operation. They will also serve as an introduction to some of the more advanced features. It will take you about half an hour to gather experience enough to continue exploring the world of counting on your own.

Getting Familiar with the Counter

The front panel is laid out in a logical fashion. Take a few seconds to find the sections described below on the front panel of your counter. See also the figure on this page. It will help you locate the different keys faster.

User Interface

The fundamental idea has been to facilitate even complex measurements by a consistent interactive user interface that fully exploits the large graphic display. The casual as well as the frequent user will benefit from a combination of hard and soft keys. In this context hard keys either act immediately or open fixed menus, whereas the function of soft keys depends on the display information.

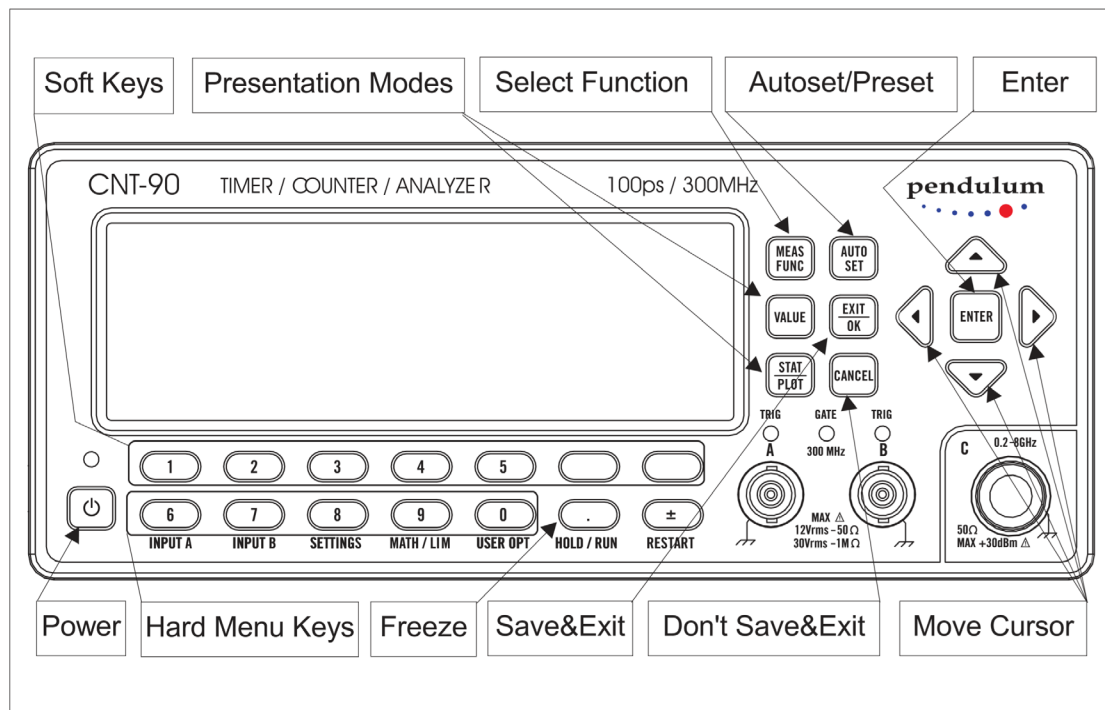

Description of Keys

Power

The ON/OFF key is a toggling secondary power switch. Part of the instrument is always on as soon as line power is applied, and this so-called standby condition is indicated by a red LED above the key.

Select Function

This hard key is marked MEAS FUNC. When you depress it, the menu below will open.



The current selection is indicated by text inversion. Select the measurement function you want by depressing the corresponding soft key right below the display. A new menu will appear where the contents depend on the function. If you for instance have selected Frequency, you can then select between Frequency, Frequency Ratio and Frequency Burst. Finally you can also change the preselected input channel.

Autoset/Preset

By depressing the AUTOSSET key once after selecting the wanted measurement function and input channel, you will most probably get a measurement result. The AUTOSSET system ensures that the trigger levels are set optimally for each combination of measurement function and input signal amplitude, provided that you apply relatively normal signals.

By depressing the AUTOSSET key twice within two seconds, you will enter the Preset mode, which takes you another step further towards fully automatic settings for your current measurement. Such auxiliary functions as measuring time, mathematics, filter and arming are then reset to their default values. The intention is to prevent possible lockups and misinterpretations when changing measurement function or test setup, for instance.

Move Cursor

There are four cursor keys for moving the cursor, normally marked by text inversion, around the menu trees.

Enter

When you want to confirm a choice without leaving your menu position, press this key.

Exit/OK

This hard key performs the Save & Exit operation. You will confirm your selections by depressing the key, and at the same time you will exit the current level and enter the next higher level in the menu tree.

Cancel

This hard key performs the Don't Save & Exit operation. You will exit the current level by depressing the key and enter the next higher level in the menu tree without confirming any selections made.

Presentation Modes

VALUE



The Value Mode gives the result of the main measurement function as a numerical value in large characters with full resolution. In addition, the results of supplementary measurements are displayed in smaller characters with limited resolution near the bottom of the screen.



In case the Limits Alarm function is enabled, Range is the selected Limit Mode, and Alarm is the selected Limit Behavior, then a simple graph is also given in which the result of the current measurement is shown as an 'emoticon' at a position relative to the limits set by the operator. Values are represented by a smiling face when inside the limits and a frowning face when outside.

If one of the limits has been exceeded, the limit indicator at the top of the display will be flashing. Only data inside the limits is used for autoscaling, so results outside the visible graph area are replaced by an arrowhead at the left or the right edge of the display.

STAT/PLOT

If you want to analyze a number of successive measurements using statistical methods, this is the key to operate. There are three display modes available by toggling this key:

- Numerical Mode
- Histogram Mode
- Trend Plot Mode

Numerical Mode

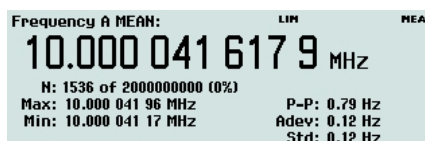

In this mode the statistical information is displayed as numerical data containing the following elements:

- Mean: running mean value of the main measurement over N samples
- Max: maximum value
- Min: minimum value
- P-P: peak-to-peak deviation
- Adev: Allan deviation
- Std: standard deviation

Histogram Mode

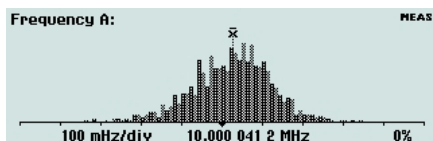

Successive measurement results are converted into a histogram. The number of bins along the horizontal axis can be set by the user through the Settings -> Stat menu. The bins in the histogram are autoscaled based on the measured data. Limits, if enabled, and the running mean value X are shown as vertical dotted lines. The center of the graph is indicated by a filled triangle on the X-axis. The corresponding numerical value is displayed below it and so is the scale factor. Enabled limits affect the autoscaling so as to visualize the current measurements and the set limits simultaneously.

Trend Plot Mode

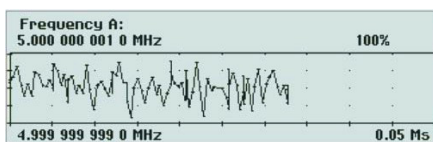

This mode is used for observing periodic fluctuations or possible trends. A trend plot terminates (if HOLD is activated) or restarts (if RUN is activated) after the set number of samples has been completed. The trend plot is always autoscaled based on the measured data, starting with 0 at restart. Limits are shown as horizontal lines, if enabled.

Remote

When the instrument is controlled from the GPIB bus, and the remote line is asserted, or when the instrument is controlled from the USB bus, then the presentation mode changes to Remote, indicated by the label REM on the display. The main measurement result and the input settings are displayed in this mode.

Hard Menu Keys

These keys are mainly used for opening fixed menus, from which further selections can be made, for instance by means of the soft keys.

Input A

By depressing this key, the bottom part of the display will show the settings for Input A.

The active settings are in bold characters and can be changed by pressing the corresponding soft key below the display. You can also move the cursor, indicated by text inversion, with the RIGHT and the LEFT arrow keys to the desired position and then make the selection by pressing the UP or the DOWN arrow keys. You can also use the ENTER key.

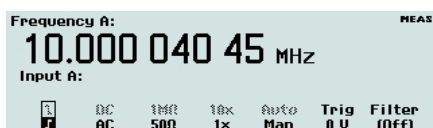

The selections that can be made in this menu are:

- Trigger Slope: positive or negative, indicated by corresponding symbols
- Coupling: AC or DC
- Impedance: 50 Q or 1 MQ
- Attenuation: 1x or 10x
- Trigger: Manual or Auto (always Auto 10/90 % when measuring transition times).
- Trigger Level: If Manual has been selected, the absolute level can be adjusted with the up/down arrow keys or by entering a numerical value from the keyboard.

- Filter: On or Off. Pressing ENTER or the soft key below the text opens up the Filter Settings menu. See below.

You can select a fixed 100 kHz analog



filter or an adjustable digital filter. The equivalent cutoff frequency is set via the value input menu that opens if you select Digital LP Frequency from the menu above.

Input B

The available settings under Input B are equal to those available under Input A.

Settings

This key accesses a range of more sophisticated instrument settings that usually need not be changed for basic measurements. The figure below shows the display after recalling the default settings via the USER OPT menu.



A detailed description of all the possibilities is far beyond the scope of this introductory manual. See the User's Manual for full details on functions mentioned and unmentioned here.

Meas Time



This value input menu is only useful if you select a frequency function. Longer measuring time means fewer measurements per second but gives higher resolution. You can change the Measuring Time by entering a numerical value, or you can use the UP/DOWN arrow keys to increase or decrease the current value.

Burst

This settings menu facilitates measurements on pulse-modulated signals and is only useful if Frequency Burst is the main measurement function.

Both the carrier frequency and the modulating frequency – also known as the pulse repetition frequency (PRF) – can be measured, often without the support of an external arming signal (see below).

Arm

Arming is the general term used for the means to control the actual start or stop of a measurement. When arming is used, the normal free-running mode is inhibited, and triggering takes place only when certain pretrigger conditions are fulfilled.

The signal(s) used for initiating the arming can be applied to three channels, and the start channel can be different from the stop channel. All conditions can be set via the menu below.



Trigger Hold-Off

In this menu you can set the delay during which the stop trigger conditions are ignored after the measurement start. A typical use is to clean up signals generated by bouncing relay contacts.

Statistics

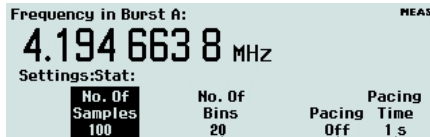

In this menu you can find the following submenus:

- No. of Samples: Set the number of samples used for calculation of various statistical measures.
- No. of Bins: Set the number of bins used in the histogram mode.
- Pacing: Set the delay between successive measurements, called Pacing Time, to ON or OFF.
- Pacing Time: Set the pacing time to a value between 2 μ s – 1000 s.

Timebase Reference



Here you can select if the counter is to use the internal or an external timebase reference. If Auto is selected, an external timebase will be used only if it is interpreted as a valid signal, i.e. both amplitude and frequency must be within specified limits. This does not imply, however, that an external reference source has to be better in any sense than the internal timebase oscillator. The EXT REF indicator at the upper right corner of the display shows that the instrument is using an external timebase reference.

Miscellaneous



The options in this menu are:

- Smart Time Interval: When selected, the counter decides by means of timestamping which measurement channel is leading.
- Auto Trig LF: In a value input menu you can set the lower frequency limit for automatic triggering and voltage measurements in the range 1 Hz – 100 kHz. A higher limit means faster settling time and consequently faster measurements.
- Timeout
Switch the Timeout function ON or OFF. In case the input signal gets interrupted, the timeout system (if enabled) will hold the last measurement result on screen only during the selected period of time (see next paragraph). Then the screen will be blanked, and a pending bus query will read a zero result. In case timeout is switched off when the signal gets interrupted, the display will freeze, i.e. the result of the last complete measurement will stay on screen indefinitely. A pending bus query will also wait indefinitely for a response, unless the test system controller has enabled its own timeout.
- Timeout Time
Set the maximum time the instrument will wait for a pending measurement to finish before outputting a zero result. The range is 10 ms to 1000 s.
- Math/Limit
Here you will find the menus for mathematical postprocessing of the measurement result and for setting up the limit testing function.

Math

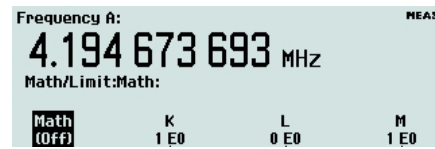

You can modify the measurement result mathematically by scaling or offsetting before presentation on the display. This feature can be used for getting revolutions/min instead of Hz or for recalculating the frequency in case a device causing frequency conversion (e.g. a multiplier or a mixer) is part of the system under test.



Select one of four formulas and enter the constants K, L and M to make the counter show directly what you want, without tedious recalculations. X stands for the current unmodified measurement result. See the User's Manual for a closer description.

Limits

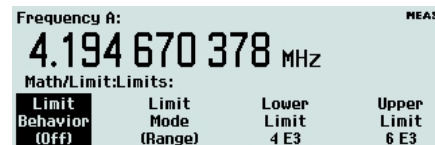

This menu is used for setting numerical limits and selecting the way the instrument will report the measurement results in relation to them. See the section Presentation Modes on page 3-4 for a short description or the User's Manual for a more detailed description.

User Options

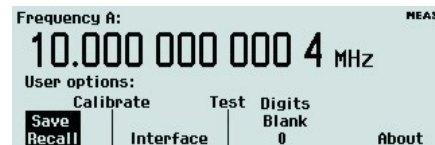

From this menu you can reach a number of functions that are not directly involved in the measurement process.

Save/Recall Menu



Twenty complete front panel setups can be stored in nonvolatile memory; the first ten of them can be user-protected. The different setups can be individually labeled to make it easier for the operator to remember the application.

The following can be done:

- Save Current Setup: Select one of twenty positions.
- Recall Setup: Here you will find a factory-programmed default setup as well as any setups you may have stored before.
- Modify Labels: The seven soft keys right below the display plus the numeric input keys 6, 7, 8, 9, 0 are used for entering lower-case letters and digits much in the same way as you write SMS messages on a cell phone. Each label can hold seven characters.



- Setup Protect: ON or OFF. Only setup positions 1-10 can be protected against inadvertent overwriting.

Calibration Menu

This counter has an extensive system for closed-case calibration by software. Refer to the Service Manual for details.

Interface Menu

Set the active interface to GPIB or USB and enter the GPIB address.

- Bus Type: Choose GPIB or USB
- GPIB Mode: There are two alternative command systems, Native and Compatible. See the User's Manual and the Programmer's Handbook for details.
- GPIB Address: Enter the bus address, an integer between 0 and 31. The factory default value is 10.

Test Menu

Different parts of the hardware can be tested by means of built-in software support.

Test Mode

You can select among the following test modes:

- All (The five individual tests below are performed in sequence)
- Memory (RAM) test
- Memory (ROM) test
- Logic hardware test
- LCD & display drivers test
- Interface test

Start Test

Press this key to run the selected test.

About (Information)

Read status information about the instrument.

- Model
- Serial number
- Firmware version
- Factory-installed options
- Calibration date

Hold/Run

This key serves the purpose of manual arming. A pending measurement will be finished and the result will remain on the display until a new measurement is triggered by pressing

the RESTART key. The HOLD sign in the upper right corner of the screen indicates that no new measurements are taking place.

Pressing the key again will resume the continuous measurement mode.

Restart

Often this key is operated in conjunction with the HOLD/RUN key (see above), but it can also be used in free-running mode, especially when long measuring times are being used, to initiate a new measurement after a change in the input signal. RESTART will not affect any front panel settings.

Entering Numeric Values

Sometimes you may want to enter constants and limits in a value input menu, for instance after you have pressed the MATH/LIMIT key.

You may also want to select a value that is not in the list of fixed values available by pressing the UP/DOWN arrow keys. One example is Meas Time under SETTINGS.

Whenever it is possible to enter numeric values, the keys marked with digits (0,1,...9), decimal point (.) and change sign (\pm) take on this alternative numeric meaning.

It is often convenient to enter numbers using the scientific format with mantissa and exponent. When this is supported in a particular menu, the rightmost soft key will be marked EE (stands for Enter Exponent), making it easy to switch between the mantissa and the exponent.

Press EXIT/OK to store the new value or CANCEL to keep the old one.

Exercises

Preparation

For these exercises you will need a '9X' counter, a function generator and two BNC cables of approximately equal length. Set up the generator according to the following table, and connect the main output of the generator to input A of the counter.

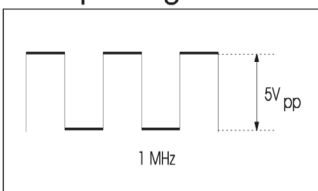
<p>Set up the generator:</p> 	Function: Square Wave
	Frequency: 1 MHz
	Amplitude: 5 V _{pp}
	Modulation: Off

Basic Startup

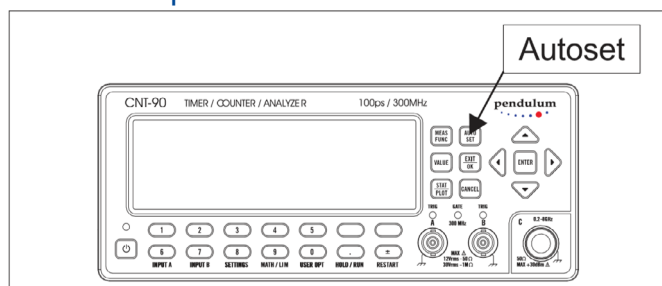

Since the counter will remember its previous setting in nonvolatile memory, it is recommended that you recall the factory default setting before you begin.

To do so, first key in the following sequence:

USER OPT Save/Recall –

– Recall Setup – Default. Then press the AUTOSET key twice within two seconds. The preselected measurement function will be Frequency, and the trigger levels will be automatically adjusted in relation to the applied signal.

If a signal with a frequency of 20 Hz or higher and an amplitude large enough to trigger the counter is connected to input A, its frequency will now be displayed.

High-Resolution Frequency Measurement

Note the high resolution of the primary readout. Twelve digits are displayed in a measuring time of 1 s. Don't worry about the trigger settings, the AUTO trigger will take care of any input signal above 20 Hz. This frequency limit can, if so desired, be changed down to 1 Hz or up to 100 kHz with a tradeoff between frequency and measurement speed. If the generator has been set up properly, you will now read the frequency (1 MHz) on the display.

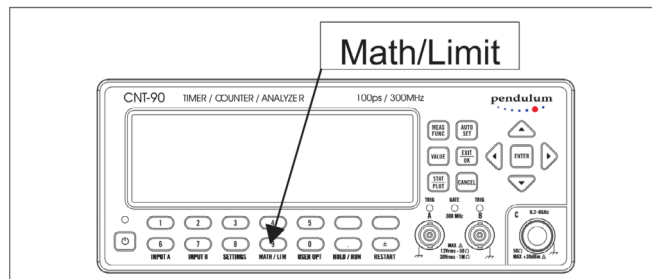

Built-In Math Processing

With the built-in math functions, you can make post-processing operations like scaling and offsetting an easy benchtop task without having to hook up a computer to the instrument. You can, for example, display any deviation from the desired value instead of directly showing the result of the measurement itself. This is known as offsetting.

In the following, the direct, unscaled result of the counter's measurement process will be referred to as 'X'.

To set up the counter to display any deviation from 1 MHz, press the MATH/LIM key and select Math. The display will show that Math is still Off. Press the soft key below the Math Off indicator to enter the Formula Select menu. Use the cursor keys to mark the formula $K \cdot X / M + L$ and confirm by pressing the EXIT/OK key.

Now enter the numerical values for the constants K, L and M. The default values are: $K=1$, $L=0$ and $M=1$. In this case only L has to be altered to $-1 \cdot 10^6$ in order to get the job done.

Open the value input menu for L by pressing the soft key below the menu heading marked L on the display. Press 1 followed by \pm , EE (short for Enter Exponent) and 6. Confirm and exit by pressing EXIT/OK. Press EXIT/OK repeatedly until the display is showing the measurement result, now modified to reflect any deviation from 1 MHz.

Change the generator frequency upward and downward just a little, and watch the counter's display.

High-Speed Measurements

The benefits of high speed measurements for benchtop use become obvious when you use statistics. For instance, the '9X' can make 1000 7-digit measurements and present the standard deviation (jitter) in less than one second.

Recall the default setting and press AUTOSET twice within two seconds before tweaking the controls to reach the optimum measurement speed for your application. See the following two paragraphs.

Under the INPUT Menus:

Auto trigger level settings in this model is so fast that you will normally not notice any difference in speed if auto is on or off. However, if you use statistics to make hundreds or thousands of measurements, the fractions of a second it takes to calculate trigger levels before each measurement add up to a considerable time over the total sequence.

The measuring speed can be increased substantially if you set the trigger levels manually once, before a lengthy measurement sequence starts.

Press INPUT A and choose MAN for the MAN/AUTO setting. Now press Trig to open the trigger level value input menu. Enter a level of +0.5 V. Confirm the selection by pressing EXIT/OK twice.

Under the SETTINGS Menu:

By making the measuring time for each sample as short as possible you can also increase the overall measuring speed. Remember, however, that there is always a tradeoff between measuring time and resolution.

Press SETTINGS and then MeasTime. Use the DOWN arrow key to set the measuring time to the minimum value. Confirm by pressing EXIT/OK twice.

Now the counter is taking measurements at a very high speed.

Toggle the STAT/PLOT key to see the statistical measures and the graphical presentation of the result.

The measuring speed can be increased even more, if you take advantage of the features that are available over the GPIB. These include commands for turning off the display update, etc. In this way you can reach speeds up to 2000 transferred measurements/s, each individually triggered. If you save the results to the internal memory of the instrument for later transfer, you can even attain an impressive speed of 250,000 measurements/s.

Time Measurements

So far we have only been using the frequency function. Now we will use some others.

To measure the period of the signal, simply press the key MEAS FUNC followed by PERIOD. Select SINGLE or AVERAGE depending on the desired resolution and measuring speed. Finish by selecting the input channel.

To measure pulse width, use the keys MEAS FUNC and PULSE followed by POS or NEG depending on whether you want to measure the positive or the negative pulse width. Finish by selecting the input channel.

Jitter Measurements (Statistics)

You can make statistical measurements, such as pulse width jitter, directly via the front panel of the counter.

Make sure the counter is measuring positive pulse width on input A. To turn on statistics, press the STAT/PLOT key. Change the display mode by toggling the same key. Return to the numerical mode and watch the results. The display gives you a survey of several statistical measures. See also page 3-4. The rms jitter is equivalent to the standard deviation of 100 measurements, where 100 is the default value for the sample size.

If you want to change the default values for sample size, bin size or pacing time, then you can press the SETTINGS menu key and after that the STAT soft key.

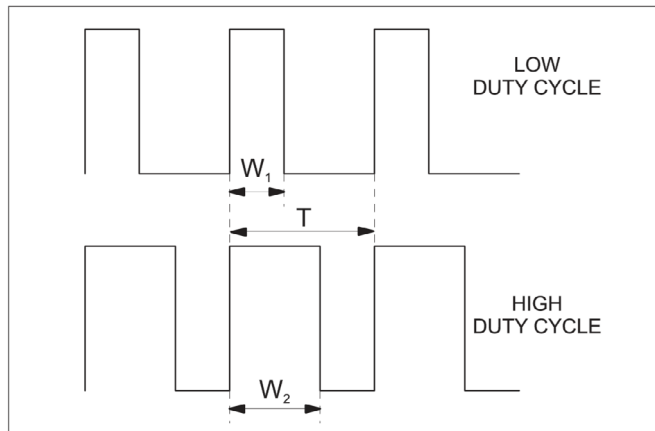

Other Single-Channel Measurements

The counter/timer can help you characterize signals even further. Recall the default settings and press AUTOSSET twice.

Duty Cycle

Use the MEAS FUNC key to select Duty and then Positive A (for positive-pulse duty cycle measurement on channel A). Change the frequency of the generator to 10 kHz. Then vary the symmetry (duty cycle) of the square wave on your generator. The counter's display will directly show the duty cycle as a number between 0 and 1. There is no need to manually calculate duty cycle by dividing pulse width by period.

The duty cycle (D) is defined as: $D = W / T$
 $D = 0.5$ for a square wave.

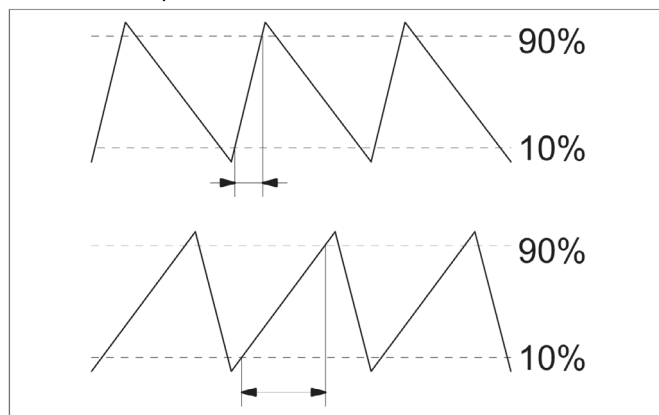

Rise Time

Use the MEAS FUNC key to select Time, Rise Time and A (for channel A). Press INPUT A and make sure the following settings are active:

- Coupling DC
- Impedance 50 Q.
- Attenuation 1x

Notice the rise time for a square wave, which is measured totally automatically.

Now change the generator output to a triangular waveform. See next figure.

Vary the rise time and notice the difference on the display.

Fall Time

Fall time is measured in a similar way by selecting Fall Time instead of Rise Time above.

Remarks

Varying the symmetry of the waveform will also vary the rise and fall times.

As you have noticed, there is no need to check max and min voltages and calculate 10 % and 90 % levels. The counter does it all automatically.

Volt Max/Min Measurements

The counter can also measure the peak voltage values of your input signal. Use the MEAS FUNC key to select Volt. Then select Vpp, Max or Min as the primary function. The results of the secondary functions are calculated simultaneously and displayed in a smaller font.

Set up the Generator:	Frequency:	200 Hz
	Waveform:	Square
	Symmetry:	50%
	Amplitude:	2-5 V

Note that the voltage reading on the counter may be lower than the setting indicated on the generator, as some generators indicate the open output voltage, while the counter is now set to 50 Q input impedance.

Channel Swapping

There is no separate key or function for swapping input channels, as found on some other counters, yet by exploring the menu trees under MEAS FUNC you will find that all measurement functions can be performed on each of the two input channels,

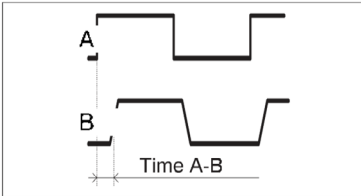
Set up the counter: 	Trigger Level: AUTO
	Function: TIME INT A-B
	Coupling: DC (both A and B)

thus eliminating the need for a swap function.

As both input channels have the same specification, the definition of primary and secondary channel (as seen with some other counters) is not relevant with the '9X' from a technical point of view.

Two-Channel Measurements

The counter can measure the timing relationship between two channels with the Time Interval A to B and Phase A rel B functions.

Time Interval

Often function generators have a TTL output in addition to the main output. We will make use of this now. Connect a BNC cable from the TTL output to Input A on the counter and another BNC cable from the main output on the function generator to Input B.

You can now read the time difference between the TTL and main outputs of the generator.

Phase

So far the counter has shown the timing relationship between the TTL and the main output of the generator as a time delay. You can also show this as phase shift between the signals.

Using Auto to set fixed trigger levels (Auto Once)

Some measurements like Phase A rel B benefit from having fixed trigger levels. This is because a change in trigger level causes a change in the measured phase shift, and Auto might change the trigger level between measurements.

To avoid calculating the trigger levels yourself, you can let the counter measure the Auto levels and then store them as fixed values.

Press INPUT A and check that Auto is still selected. Read the Auto trigger level for Input

A. Select Man. Note that the automatically calculated trigger level is now entered as a fixed manual level.

Press INPUT B and run through the same steps once more to store this level as a manually set trigger level as well.

Procedure

Use the MEAS FUNC key to select Phase A rel B. Now the channel delay is expressed as phase shift in degrees.

Increase the frequency of the generator to 2 kHz, 20 kHz, 200 kHz, 2 MHz, and

20 MHz. Watch the phase difference change.

Memory Settings

See also page 3-8.

The counter has 20 memory locations in which you can store frequently used instrument settings.

- To save an instrument setting, press the USER OPT key.
- Select the Save/Recall key.
- Press Save Current Setup, and select one of the memory locations using the LEFT/RIGHT arrow keys. Note that the first ten positions may be user-protected.
- Press EXIT/OK three times to return to the normal display mode.
- Now change some settings on the counter, and repeat the first steps above, until you have pressed Save/Recall.
- Press Recall Setup and select the memory location in which you stored your original setup.
- Press EXIT/OK three times to return to the normal display mode.
- Watch the counter restore your original settings.

The memory is nonvolatile, so it will not change if you switch off the counter, nor if you restore the default setup. All settings are stored including trigger levels, mathematical constants etc. You can even attach a label to each stored setup, which helps you identify the application easier.

Auxiliary Functions

There is a collection of useful, however seldom used auxiliary functions. Only one will be mentioned here. See the User's Manual for a more comprehensive description. Before we go on, first recall the default setup and then press AUTOSSET twice.

Time-Out

Check that the counter is measuring. Disconnect the Input A signal, and the measurement result will freeze on the display. Connect the signal again and the counter resumes measuring immediately.

Is this a feature? Well, yes and no. Yes, since this function gives touch-hold characteristics. No, since interrupted measurements giving false readouts may be misinterpreted by automatic test equipment and can even cause control SW to halt. The solution to this problem is the time-out function.

- Press the SETTINGS key and then Misc -> Timeout Time.
- Calculate the time needed to decide if there is a signal present at the input.
- Enter this time using the numerical soft keys, for instance 1 s.
- Activate the time-out function by toggling the soft key Timeout to ON.
- Disconnect the signal and check that the counter shows '---' after one second.

Keep in mind that the value you select for this time-out must always be longer than the selected measuring time.

Summary

This concludes the Getting Started Manual. Now you have been familiarized with the control structure and the display modes of the model '9X'.

There are still a great many features to discover, so have a look at the User's Manual and the Programmer's Handbook, which can be found on the CD-ROM. Continue to explore the vast realm of measurement possibilities that opens up to the user of this instrument.

CONTACT PENDULUM INSTRUMENTS

SWEDEN

phone +46 280 41122
info@pendulum-instruments.com

UNITED STATES

phone +1(866) 644-1230
us-office@pendulum-instruments.com

POLAND

phone. +48 (58) 681 8901
info@pendulum-instruments.com

© Pendulum Instruments 2021
March 06, 2020. CNT-90 Series rev.1
Specifications subject to change
or improvements without notice.

pendulum

